

200W LED HIGH BAY LIGHT

AREAS OF APPLICATION

Heavy & light Industry Production
Assembly Line
Warehouse & Storage Facilities
Commercial Assembly Halls
Loading Areas
Mall & Supermarket Lighting
Aircraft Hangers

PRODUCT SPECIFICATION :

Housing : High grade Aluminium pressure Die-Cast

Lamp Efficacy : >100 lumen/Watt

System Management : Multiple LEDs are used in series - parallel cluster

Control Gear : CC-CV Control driver with efficiency >90%, current regulator for each cluster

Protection Degree : IP65/IP66

Thermal Management : Effective Heat Sinking, Ensure long life

Optics : Quality of light design to maximize distribution & intensity

Surge Protection : Upto 10KV

CRI : Superior color rendition index compared to HPSV, MH, Traditional lights

Special Feature : Over voltage protection , Reverse EMI protection provided , Short circuit protection , Open circuit protection

BIS : BIS approved driver IS 15885 (Part 2/Sec13) :2012 , R-84000787

Technical Details :

Model No.	Rated Wattage	Nominal Voltage	Color	CRI	PF	THD	Lumen O/P
MLAC-HB200L	200W	140V-285V	CW/WW	>80	>0.95	<10%	20000 lm

Dimensions :

Wattage	Diameter	Height
200W	430mm	160mm

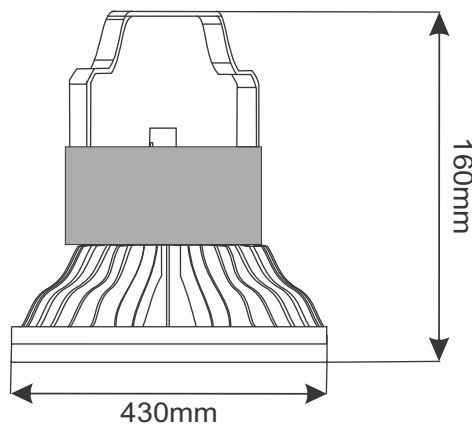

Saving at a Glance :

LED vs. HID savings at a glance

Why are so many facilities making the switch from HID to LED?

The numbers say it all.

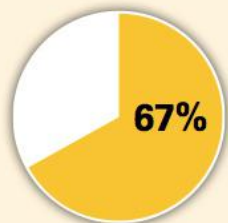

67% REDUCTION IN ENERGY COSTS

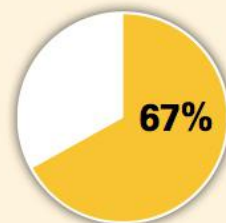

67% LOWER TOTAL COST OF OWNERSHIP



100% MAINTENANCE REDUCTION